



NEMA Receptacle UL498 5-15R

0710 Series

Power Rating : 15A 125V AC

Insulation Resistance : over 100MΩ 500V DC

Withstanding Voltage : 2,000V AC One Minute

Operating Rating Temperature : -25°C to +85°C

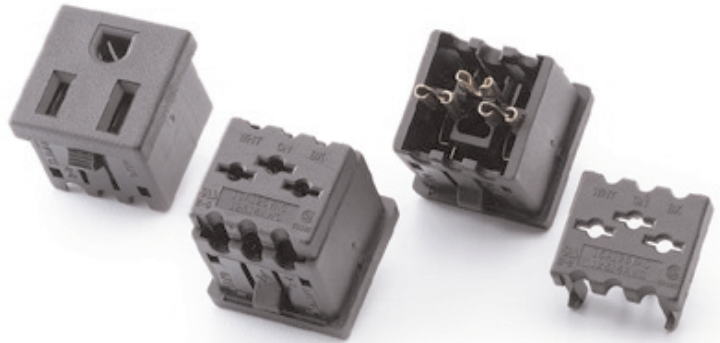

Main Unit Material : Thermoplastic UL Flammability 94V-0 & Copper Alloy

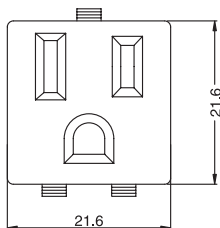
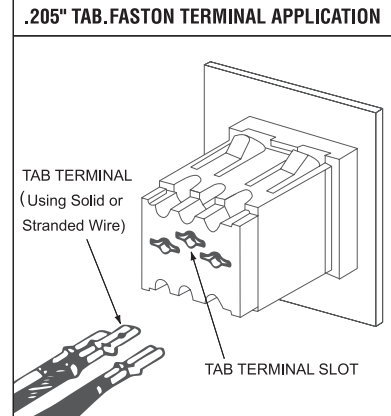
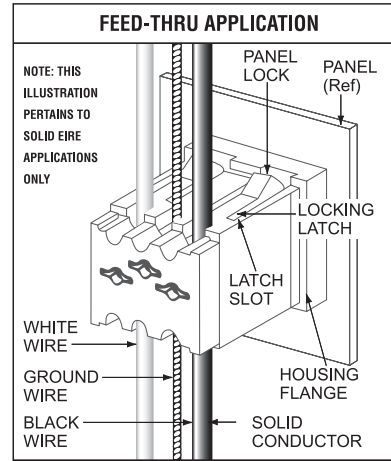
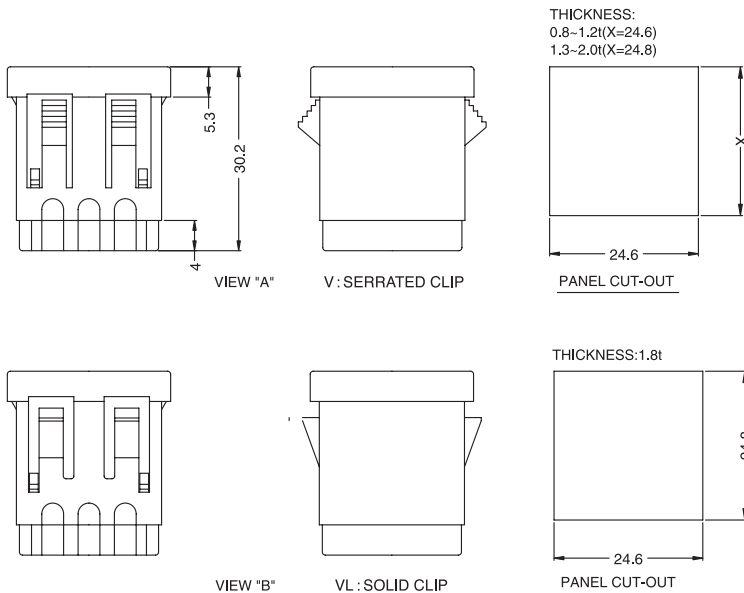

2-Pole 3-Wire Grounding Receptacle

Unit:mm



ORDER NO.	CODE	VIEW	TERMINAL OPTION
0710-PV12	V	A	AWG 12 & 14 15A 125V (SOLID WIRE)  1.35
0710-PVL12	VL	B	
0710-PV16	V	A	AWG 16 13A 125V (SOLID WIRE)  0.8
0710-PVL16	VL	B	

