

Part No. **AL-314OR5C-002**

Diff No.002

3 mm

Round

Type : LED Lamps

■ Package Dimension:

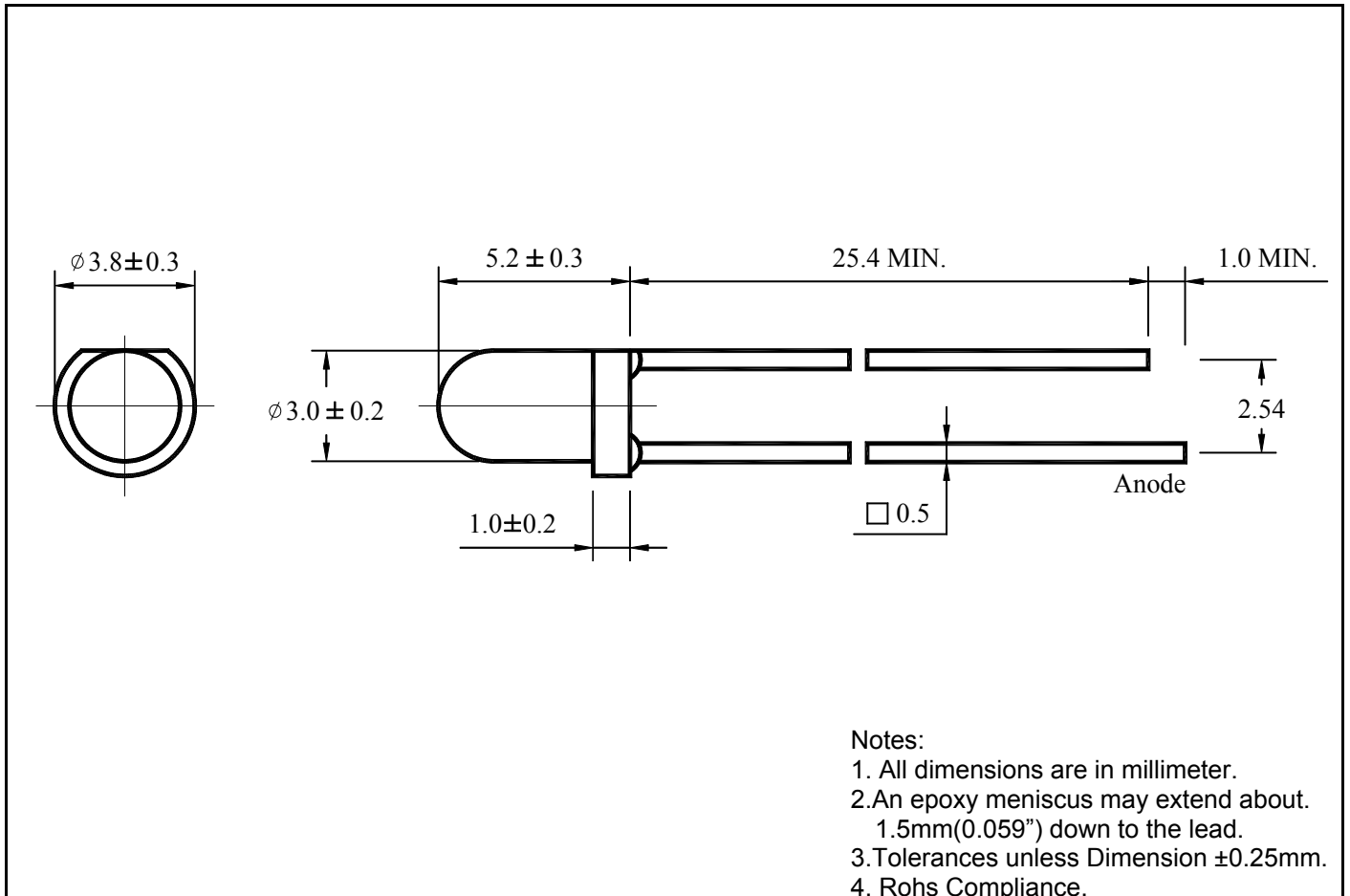

■ Features :

- Choice of various viewing angles.
- Available on Tape and Reel.
- Reliable and robust.

■ Descriptions :

- The series is specially designed for application requiring higher brightness.
- The LED lamps are available with different color, intensities, epoxy colors etc.

■ Applications :

- TV set
- Monitor
- Telephone

Part No. **AL-314OR5C-002** Diff No.002

3 mm

Round

Type : LED Lamps

LED Parts P/N.	Chip		Lens Color
	Material	Emitted Color	
AL-314OR5C-002	AlGaInP	Super Red	Water Clear

■ Absolute Maximum Ratings at Ta=25°C

Parameter	Symbol	Rating	Unit
Continuous Forward Current	I_F	50	mA
Operating Temperature	T_{opr}	-40~+85	°C
Storage Temperature	T_{stg}	-40~+85	°C
Soldering Temperature	T_{sol}	260±5	°C
Electrostatic Discharge	ESD	1000	V
Power Dissipation	P_D	120	mW
Peak Forward Current (Duty 1/10@1KHz)	I_F (Peak)	100	mA
Reverse Voltage	V_R	5	V

■ Electronic Optical Characteristics :

Parameter	Symbol	Min.	Typ.	Max.	Unit	Condition
Luminous Intensity	I_v	2300	3500	/	mcd	$I_F=20mA$
Viewing Angle	2θ 1/2	/	20	/	deg	- - -
Peak Wavelength	λ_p	/	630	/	nm	$I_F=20mA$
Dominant Wavelength	λ_d	/	625	/	nm	$I_F=20mA$
Spectrum Radiation Bandwidth	$\Delta\lambda$	/	20	/	nm	$I_F=20mA$
Forward Voltage	V_F	/	2.0	2.4	V	$I_F=20mA$
Reverse Current	I_R	/	/	10	μA	$V_R=5V$

Part No. **AL-314OR5C-002** Diff No.002

3 mm

Round

Type : LED Lamps

■ Reliability test items and conditions :

The reliability of products shall be satisfied with items listed below.

Confidence level: 90%

LTPD: 10%

NO	ITEM	Test Conditions	Test hours/cycle	Sample Q'ty	Ac/Re
1	Solder Heat	Temp : 260°C±5°C	5 sec	22 pcs	0/1
2	Temperature Cycle	H : +100°C 15min ↳ 5min L : -40°C 15min	50 cycles	22 pcs	0/1
3	Thermal Shock	H : +100°C 15min ↳ 10sec L : -10°C 15min	50 cycles	22 pcs	0/1
4	High Temperature Storage	Temp : 100°C	1000 hrs	22 pcs	0/1
5	Low Temperature Storage	Temp : -40°C	1000 hrs	22 pcs	0/1
6	DC Operating Life	I _F =20mA	1000 hrs	22 pcs	0/1
7	High Temperature / High Humidity	85°C / 85%RH	1000 hrs	22 pcs	0/1

Part No.

AL-314OR5C-002

Diff No.002

3 mm

Round

Type : LED Lamps

■ **Typical electro-optical characteristics curves :**

The data typical and the value are not guaranteed.

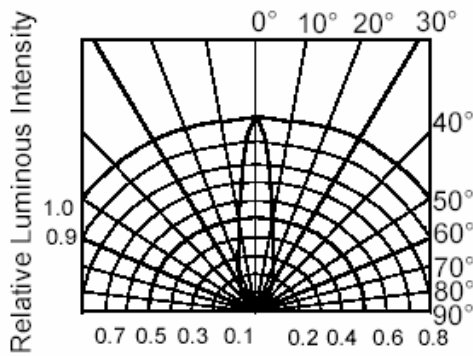

RADIATION DIAGRAM

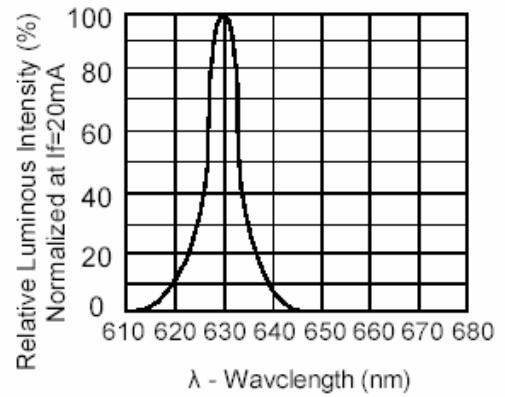

RELATIVE LUMINOUS INTENSITY Vs. WAVELENGTH

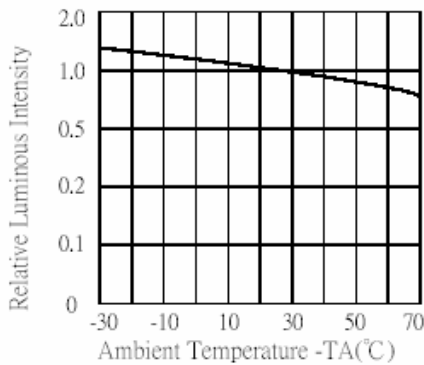

LUMINOUS INTENSITY Vs. AMBIENT TEMPERATURE

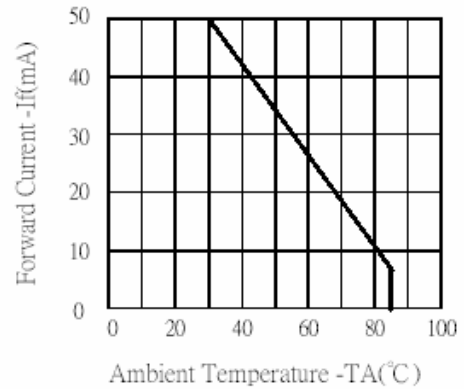

FORWARD CURRENT Vs. AMBIENT TEMPERATURE

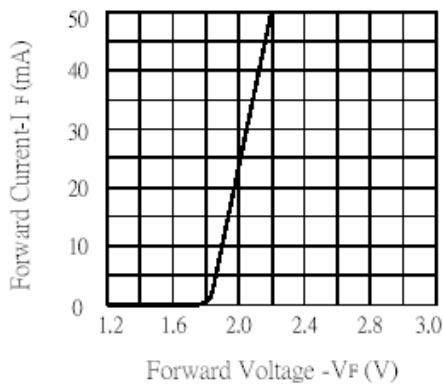

FORWARD CURRENT Vs. FORWARD VOLTAGE

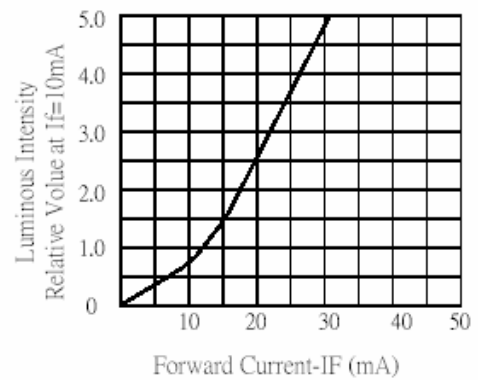

LUMINOUS INTENSITY Vs. FORWARD CURRENT