

Part No.

**AL-513B7C-002**

Diff No.002

5 mm

Round

Type : LED Lamps

■ Package Dimension:

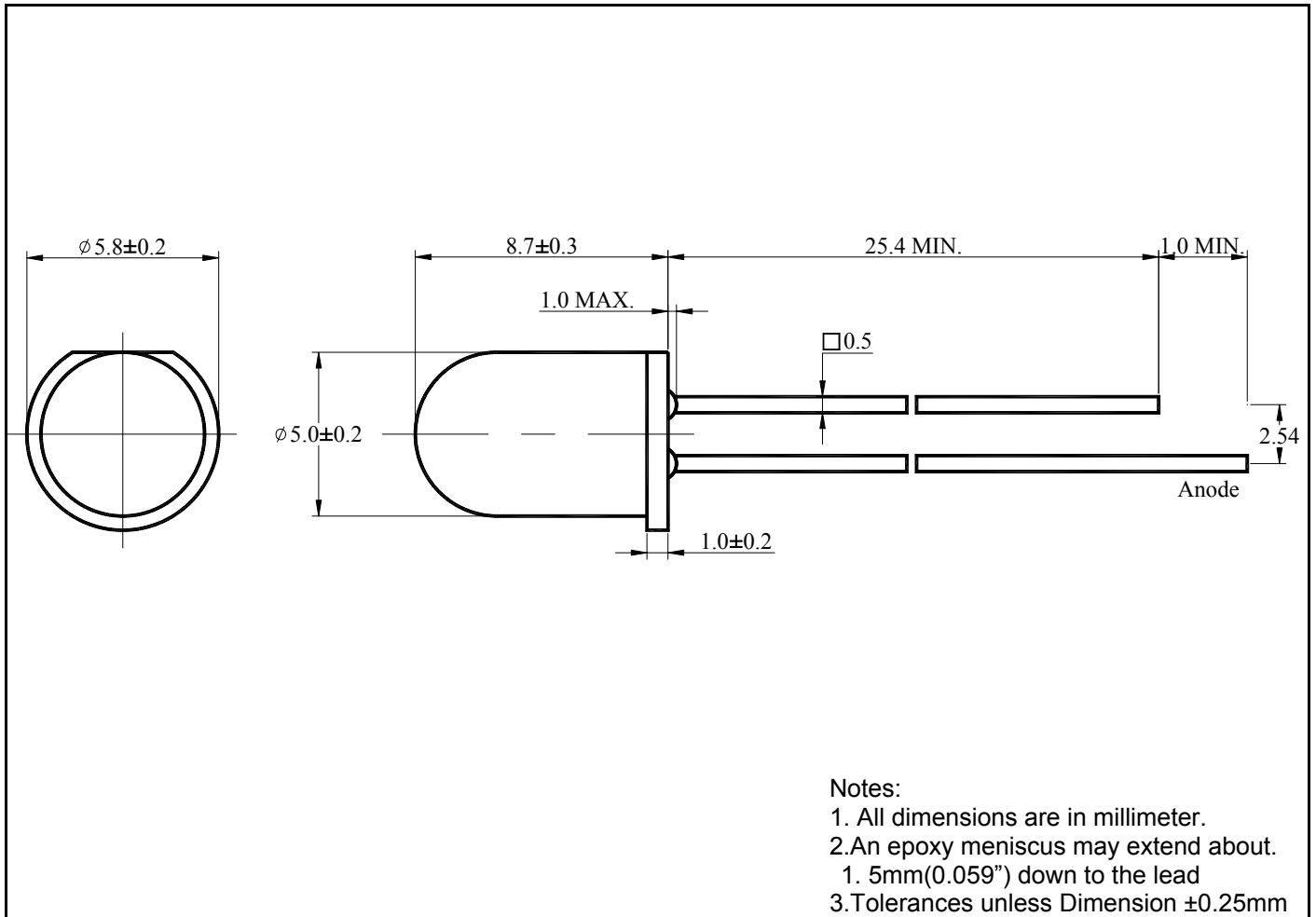

■ Features :

- Choice of various viewing angles.
- Available on Tape and Reel.
- Reliable and robust.

■ Descriptions :

- The series is specially designed for application requiring higher brightness.
- The LED lamps are available with different color, intensities, epoxy colors etc.

■ Applications :

- TV set
- Monitor
- Telephone

Part No. **AL-513B7C-002**

Diff No.002

5 mm

Round

Type : LED Lamps

LED Parts P/N.	Chip		Lens Color
	Material	Emitted Color	
AL-513B7C-002	InGaN	Super Blue	Water Clear

■ Absolute Maximum Ratings at Ta=25°C

Parameter	Symbol	Rating	Unit
Continuous Forward Current	I <sub>F</sub>	30	mA
Operating Temperature	T <sub>opr</sub>	-40~+85	°C
Storage Temperature	T <sub>stg</sub>	-40~+100	°C
Soldering Temperature	T <sub>sol</sub>	260±5	°C
Electrostatic Discharge	ESD	1000	V
Power Dissipation	P <sub>D</sub>	120	mW
Peak Forward Current (Duty 1/10@1KHz)	I <sub>F</sub> (Peak)	100	mA
Reverse Voltage	V <sub>R</sub>	5	V

■ Electronic Optical Characteristics :

Parameter	Symbol	Min.	Typ.	Max.	Unit	Condition
Luminous Intensity	I <sub>v</sub>	5300	8000	/	mcd	I <sub>F</sub> =20mA
Viewing Angle	2θ 1/2	/	15	/	deg	- - -
Peak Wavelength	λ <sub>p</sub>	/	472	/	nm	I <sub>F</sub> =20mA
Dominant Wavelength	λ <sub>d</sub>	/	470	/	nm	I <sub>F</sub> =20mA
Spectrum Radiation Bandwidth	Δλ	/	30	/	nm	I <sub>F</sub> =20mA
Forward Voltage	V <sub>F</sub>	/	3.5	4.0	V	I <sub>F</sub> =20mA
Reverse Current	I <sub>R</sub>	/	/	10	μA	V <sub>R</sub> =5V

Part No. **AL-513B7C-002**

Diff No.002

5 mm

Round

Type : LED Lamps

**■ Reliability test items and conditions :**

The reliability of products shall be satisfied with items listed below.

Confidence level: 90%

LTPD: 10%

NO	ITEM	Test Conditions	Test hours/cycle	Sample Q'ty	Ac/Re
1	Solder Heat	Temp : 260°C±5°C	5 sec	22 pcs	0/1
2	Temperature Cycle	H : +100°C 15min ∩ 5min L : -40°C 15min	50 cycles	22 pcs	0/1
3	Thermal Shock	H : +100°C 15min ∩ 10sec L : -10°C 15min	50 cycles	22 pcs	0/1
4	High Temperature Storage	Temp : 100°C	1000 hrs	22 pcs	0/1
5	Low Temperature Storage	Temp : -40°C	1000 hrs	22 pcs	0/1
6	DC Operating Life	I <sub>F</sub> =20mA	1000 hrs	22 pcs	0/1
7	High Temperature/ High Humidity	85°C / 85%RH	1000 hrs	22 pcs	0/1

Part No.

**AL-513B7C-002**

Diff No.002

5 mm

Round

Type : LED Lamps

■ **Typical electro-optical characteristics curves :**

The data typical and the value are not guaranteed.

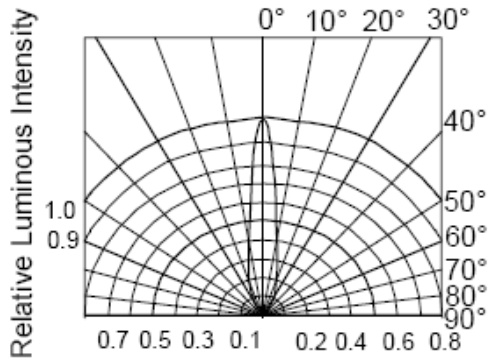

**RADIATION DIAGRAM**

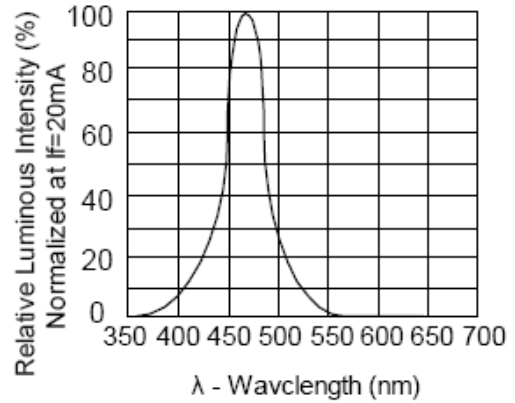

**RELATIVE LUMINOUS INTENSITY Vs. WAVELENGTH**

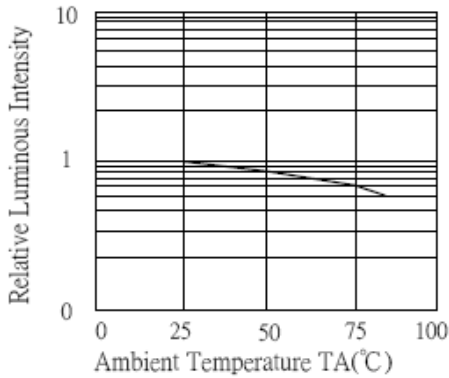

**LUMINOUS INTENSITY Vs. AMBIENT TEMPERATURE**

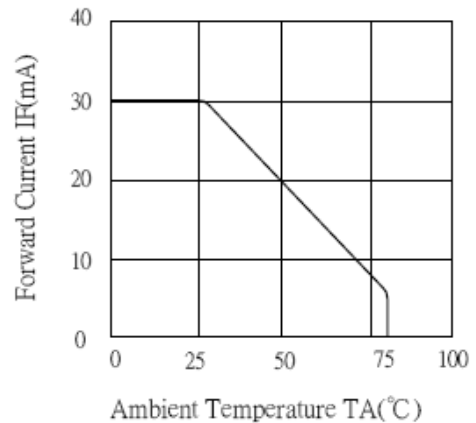

**FORWARD CURRENT Vs. AMBIENT TEMPERATURE**

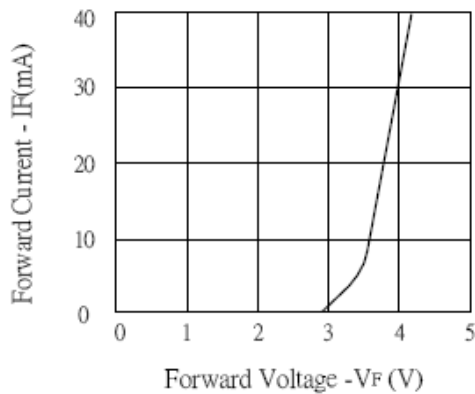

**FORWARD CURRENT Vs. FORWARD VOLTAGE**

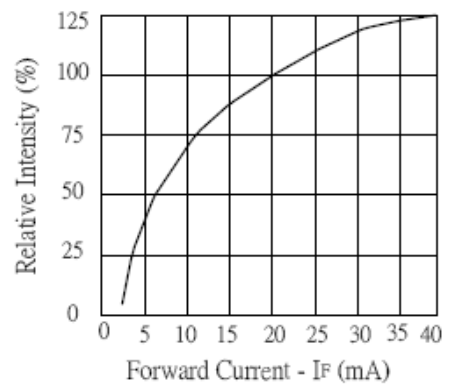

**LUMINOUS INTENSITY Vs. FORWARD CURRENT**