

Part No. **AL-513OR5C-002**

Diff No.002

5 mm

Round

Type : LED Lamps

■ Package Dimension:

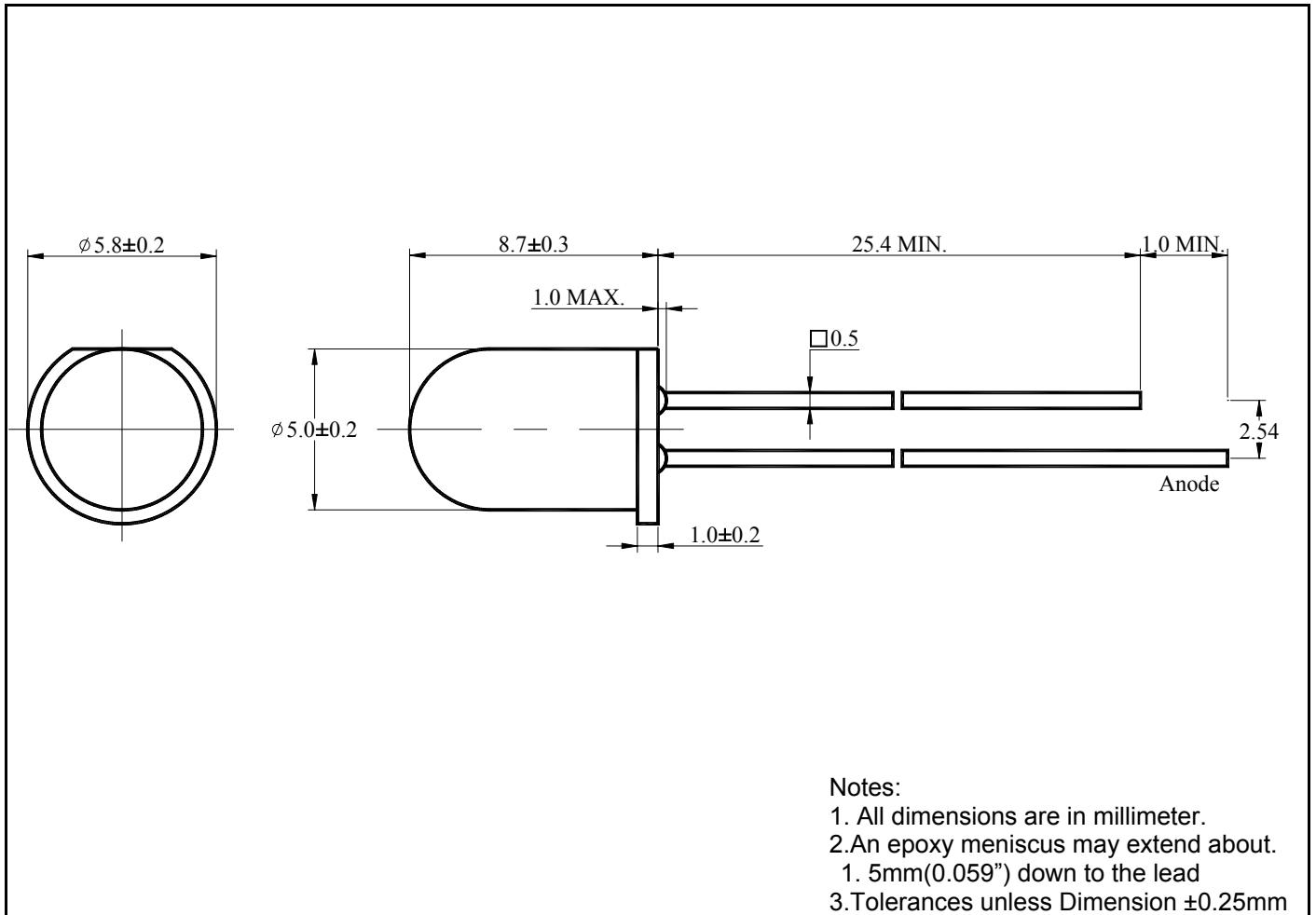

■ Features :

- Choice of various viewing angles.
- Available on Tape and Reel.
- Reliable and robust.

■ Descriptions :

- The series is specially designed for application requiring higher brightness.
- The LED lamps are available with different color, intensities, epoxy colors etc.

■ Applications :

- TV set
- Monitor
- Telephone

Part No. **AL-513OR5C-002**

Diff No.002

5 mm

Round

Type : LED Lamps

LED Parts P/N.	Chip		Lens Color
	Material	Emitted Color	
AL-513OR5C-002	AlGaInP	Super Red	Water Clear

■ Absolute Maximum Ratings at Ta=25°C

Parameter	Symbol	Rating	Unit
Continuous Forward Current	I _F	50	mA
Operating Temperature	T _{opr}	-40~+85	°C
Storage Temperature	T _{stg}	-40~+85	°C
Soldering Temperature	T _{sol}	260±5	°C
Electrostatic Discharge	ESD	1000	V
Power Dissipation	P _D	120	mW
Peak Forward Current (Duty 1/10@1KHz)	I _F (Peak)	200	mA
Reverse Voltage	V _R	5	V

■ Electronic Optical Characteristics :

Parameter	Symbol	Min.	Typ.	Max.	Unit	Condition
Luminous Intensity	I _v	4600	7000	/	mcd	I _F =20mA
Viewing Angle	2θ 1/2	/	15	/	deg	- - -
Peak Wavelength	λ _p	/	630	/	nm	I _F =20mA
Dominant Wavelength	λ _d	/	625	/	nm	I _F =20mA
Spectrum Radiation Bandwidth	Δλ	/	20	/	nm	I _F =20mA
Forward Voltage	V _F	/	2.0	2.4	V	I _F =20mA
Reverse Current	I _R	/	/	10	μA	V _R =5V

Part No. **AL-513OR5C-002**

Diff No.002

5 mm

Round

Type : LED Lamps

■ Reliability test items and conditions :

The reliability of products shall be satisfied with items listed below.

Confidence level: 90%

LTPD: 10%

NO	ITEM	Test Conditions	Test hours/cycle	Sample Q'ty	Ac/Re
1	Solder Heat	Temp : 260°C±5°C	5 sec	22 pcs	0/1
2	Temperature Cycle	H : +100°C 15min ∧ 5min L : -40°C 15min	50 cycles	22 pcs	0/1
3	Thermal Shock	H : +100°C 15min ∧ 10sec L : -10°C 15min	50 cycles	22 pcs	0/1
4	High Temperature Storage	Temp : 100°C	1000 hrs	22 pcs	0/1
5	Low Temperature Storage	Temp : -40°C	1000 hrs	22 pcs	0/1
6	DC Operating Life	I _F =20mA	1000 hrs	22 pcs	0/1
7	High Temperature / High Humidity	85°C / 85%RH	1000 hrs	22 pcs	0/1

Part No.

AL-513OR5C-002

Diff No.002

5 mm

Round

Type : LED Lamps

■ **Typical electro-optical characteristics curves :**

The data typical and the value are not guaranteed.

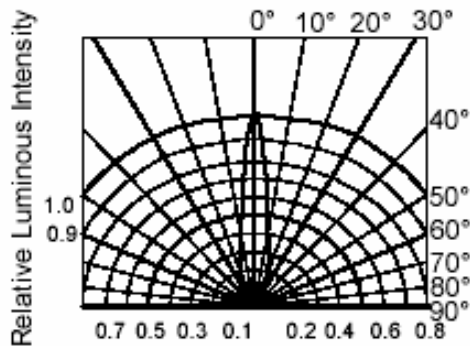

RADIATION DIAGRAM

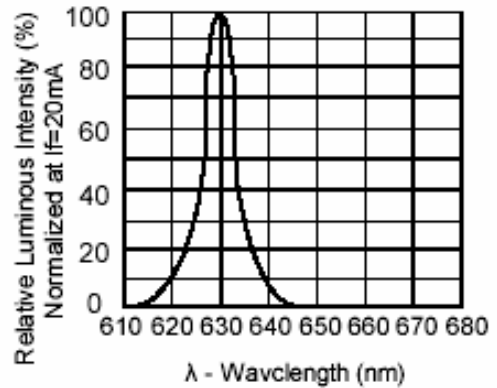

RELATIVE LUMINOUS INTENSITY Vs. WAVELENGTH

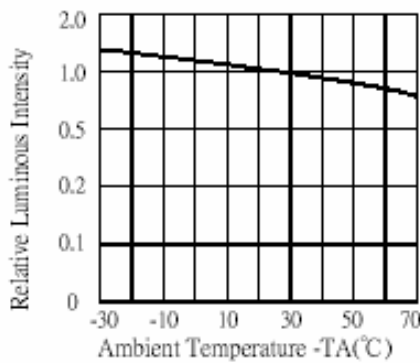

LUMINOUS INTENSITY Vs. AMBIENT TEMPERATURE

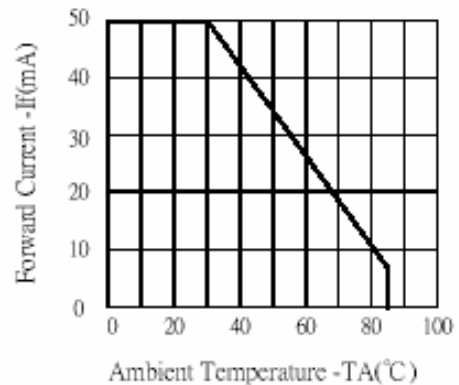

FORWARD CURRENT Vs. AMBIENT TEMPERATURE

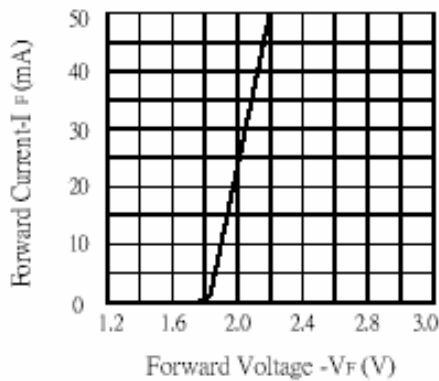

FORWARD CURRENT Vs. FORWARD VOLTAGE

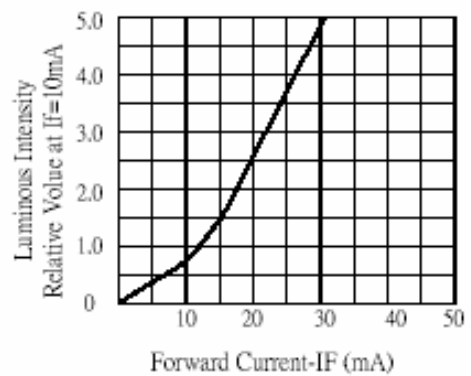

LUMINOUS INTENSITY Vs. FORWARD CURRENT