

Version : 1.1

<p style="text-align: center;">TECHNICAL SPECIFICATION</p> <p style="text-align: center;">MODEL NO. : PD064VT2</p>
--

Customer's Confirmation

Customer _____

By _____

PVI's Confirmation

Confirmed By _____

Prepared By _____

PRIME VIEW INTERNATIONAL CO.,LTD.
3,LI SHIN RD. 1,SCIENCE-BASED INDUSTRIAL
PARK,HSINCHU,TAIWAN,R.O.C.
<http://www.pvi.com.tw>

Date :August 15, 2001

This technical specification is subject to change without notice.
Please return 1 copy with your signature on this page for approval.

TECHNICAL SPECIFICATION**CONTENTS**

NO.	ITEM	PAGE
-	Cover	1
-	Contents	2
1	Application	3
2	Features	3
3	Mechanical Specifications	3
4	Mechanical Drawing of TFT-LCD module	4
5	Input / Output Terminals	6
6	Absolute Maximum Ratings	7
7	Electrical Characteristics	7
8	Power On Sequence	13
9	Optical Characteristics	14
10	Reliability Test	16
11	Block Diagram	17
12	Packing Diagram	18
-	Revision History	19

1. Application

This product applies computer peripheral, industrial meter, image communication, web-pad, e-boobs and multi-media.

2. Features

- . Pixel in stripe configuration
- . Slim and compact
- . Display Colors : 262,144 colors
- . Viewing Direction : 6 o'clock
- . Slim module design for mobile electronics device application

3. Mechanical Specifications

Parameter	Specifications	Unit
Screen Size	6.4 (diagonal)	inch
Display Format	640× R, G, B× 480	dot
Active Area	129.6(H)× 97.44 (V)	mm
Dot Pitch	0.0675 (H)× 0.203 (V)	mm
Pixel Pitch	0.203 (H)× 0.203 (V)	mm
Pixel Configuration	Stripe	
Outline Dimension	See Mechanical Drawing	mm
Weight	165±10	g

4. Mechanical Drawing of TFT-LCD Module

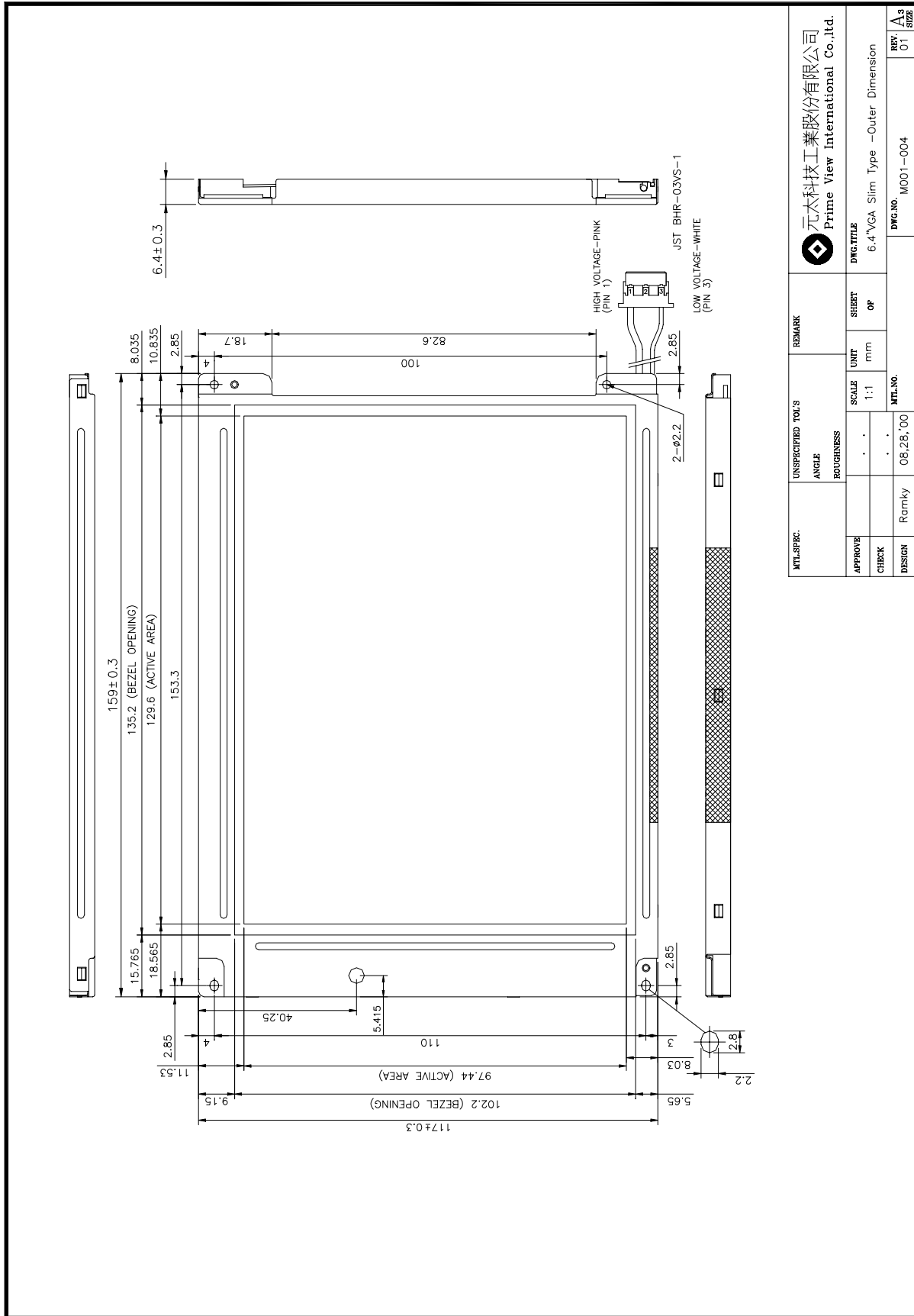

MTL SPEC.	UNSPECIFIED TOL'S	REMARK	元太科技工業股份有限公司 Prime View International Co., Ltd.	
ANGLE			DWG TITLE	6.4"VGA Slim Type -Outer Dimension
ROUGHNESS			SHEET	OF
APPROVE			SCALE	1:1
CHECK			UNIT	mm
DESIGN	Ramky		MTL NO.	08.28.00
			DWG NO.	M001-004
			REV.	01
			REV.	01
			REV.	01

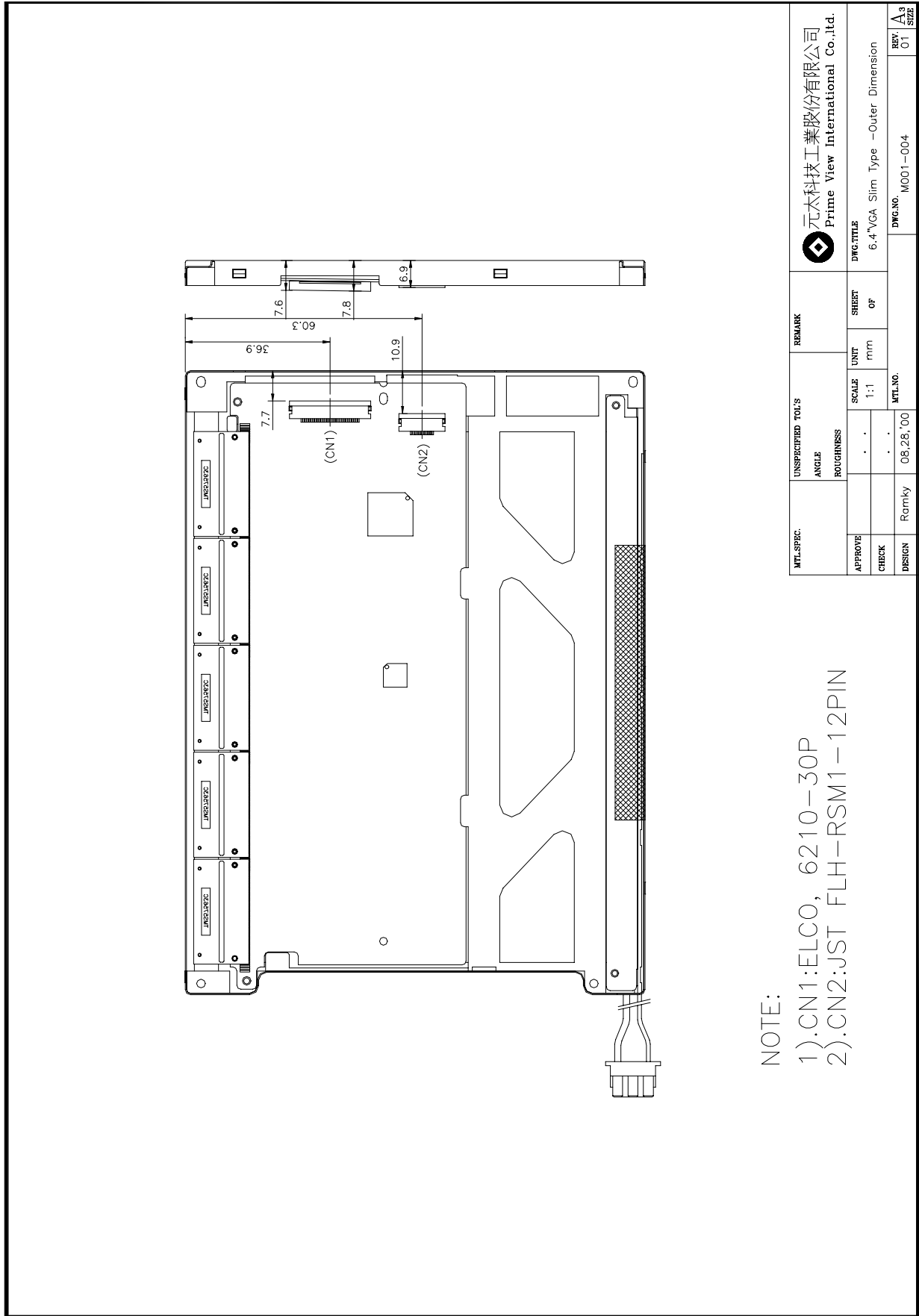

NOTE:

- 1).CN1:ELCO, 6210-30P
- 2).CN2:JST FLH-RSM1-12PIN

MTL.SPEC.	UNSPECIFIED TOL'S	REMARK	DWC.TITLE 6.4"VGA Slim Type -Outer Dimension
	ANGLE		
APPROVE	ROUGHNESS	SCALE	SHEET
CHECK		UNIT	OF
DESIGN		1:1	
		mm	
		MTL.No.	DWG.No.
	Ramky	08,28,00	M001-004
			REV.
			01
			SIZE
			A3

元太科技工業股份有限公司
Prime View International Co.,Ltd.

5. Input / Output Terminals

5-1) TFT-LCD Panel Driving

Connector(1) type : ELCO , 6210-30PIN

Pin No.	Symbol	Function	Remark
1	CLK	Clock Signal for Sampling Image Digital Data	
2	Hsync	Horizontal Synchronous Signal	
3	Vsync	Vertical Synchronous Signal	
4	GND	Ground (0V)	
5	R0	Red Image Data Signal (LSB)	
6	R1	Red Image Data Signal	
7	R2	Red Image Data Signal	
8	R3	Red Image Data Signal	
9	R4	Red Image Data Signal	
10	R5	Red Image Data Signal (MSB)	
11	GND	Ground (0V)	
12	G0	Green Image Data Signal (LSB)	
13	G1	Green Image Data Signal	
14	G2	Green Image Data Signal	
15	G3	Green Image Data Signal	
16	G4	Green Image Data Signal	
17	G5	Green Image Data Signal (MSB)	
18	GND	Ground (0V)	
19	B0	Blue Image Data Signal (LSB)	
20	B1	Blue Image Data Signal	
21	B2	Blue Image Data Signal	
22	B3	Blue Image Data Signal	
23	B4	Blue Image Data Signal	
24	B5	Blue Image Data Signal (MSB)	
25	GND	Ground (0V)	
26	NC	No connection	
27	VCC	DC +3.3V Power Supply	
28	VCC	DC +3.3V Power Supply	
29	NC	No connection	
30	NC	No connection	

5-2) Backlight driving

Pin No	Symbol	Description	Remark
1	VL1	Input terminal (Hi voltage side)	Wire color : Pink
2	NC	No Connection	
3	VL2	Input terminal (Low voltage side)	Wire Color : White Note 5-1

Note 5-1 : Low voltage side of backlight inverter connects with ground of inverter circuits.

5-3) Input / Output Connector

- A) LCD module connector
 ELCO , 6210-30PIN
 Down Connector
 Pin No. : 30
 Pitch : 0.5 mm
- B) Backlight Connector
 JST BHR-03VS-1
 Pin No. : 3
 Pitch : 4 mm
 Red: High Voltage
 White: Low Voltage

6. Absolute Maximum Ratings:

GND=0V, Ta=25°C

Parameters	Symbol	MIN.	MAX.	Unit	Remark
+3.3V Supply Voltage	V _{CC}	-0.3	+4.0	V	
Input Signals Voltage	V _{sig}	-0.3	V _{CC} +0.3	V	Note 6-1
Storage Temperature	T _{stg}	-20	+70	°C	Note 6-2
Operating Temperature	T _{opa}	-0	+60	°C	

Note 6-1: Input signals include CLK, Hsync, Vsync, R[0:5], G[0:5] and B[0:5].

Note 6-2: Humidity : 95% RH Max. at Ta ≤ 40°C.

Maximum wet-bulb temperature is at 39 °C or less at Ta > 40 °C.

No condensation.

7. Electrical Characteristics

7-1) Recommended Operating Conditions:

- A) Driving for TFT-LCD panel

GND = 0V , Ta = 25 °C

Parameters	Symbol	Min.	Typ.	Max.	Unit	Remark
+3.3V Supply Voltage	V _{CC}	+3.15	+3.3	+3.6	V	
Supply Input Ripple Voltage	V _{CCRP}			0.1	Vp-p	V _{CC} =+3.3V
Input Signals Voltage (High)	V _{IH}	+3.0	+3.3	+3.6	V	
Input Signals Voltage (Low)	V _{IL}	-	0	+0.3	V	

- B) Driving for backlight

Ta = 25 °C

Item	Symbol	Min.	Typ.	Max.	Unit	Remark
Lamp Current	I _L	3	5	7	mA	
Lamp Voltage	V _L	320	350	380	Vrms	
Oscillation	P _L	45	64	80	KHz	
Lamp Life Time		-	20,000	-	Hr	
Kick-off voltage(25°C)	Vs	-	845	1,050	Vrms	
Kick-off voltage(0°C)	Vs	-	1,045	1,250	Vrms	

7-2) Power Consumption

Parameters	Symbol	Typ.	Max.	Unit	Remark
+3.3V Current Dissipation	I_{CC}	290	330	mA	
Input Signals Current (High)	I_{IH}		100	μA	$V_{IH} = +3.3V$
Input Signals Current (Low)	I_{IL}		100	μA	$V_{IL} = 0V$
LCD Panel Power Consumption		0.96		W	Note 7-1
Backlight Power Consumption		1.75	2.66	W	Note 7-2

Note 7-1 : The power consumption of backlight is not included.

Note 7-2 : Backlight lamp power consumption is calculated by $I_L \times V_L$.

7-3) Input / Output signal timing chart

Parameters	Symbol	Min.	Typ.	Max.	Unit	Note	
Frequency	$F_c = 1/T_c$		25.175		MHz	Note 7-3	
Clock	High Time	Tckh	10		ns		
	Low Time	Tckl	10		ns		
	Periodic = Line	Thp		31.778	μs	Note 7-3	
Hsync			800	1024	clock	Note 7-3	
	Pulse Width	Thpw	2	96	200	clock	
	Back Porch	Thbp	2	49	64	clock	
			515	525	1024	line	Note 7-3
Vsync	Pulse Width	Tvpw	1	2		line	
	Back Porch	Tvbp	1	33	64	line	
Data	Setup Time	Tds	10			ns	
	Hold Time	Tdh	10			ns	
	Periodic = Line	Tep		800	1024	clock	
	Pulse Width (H)	Tepw	2	640	800	clock	
Horizontal Display Periodic	Thd	640	640	640	clock		
Hsync-CLK Phase Difference	Thc	10		Tc-10	ns		
Vsync-Hsync Phase Difference	Tvh	1		Thp-1	clock		

Note 7-3 : T_c is the period of sampling clock. In case of low-frequency, the image-flicker may occur.

7-4) Display Time Range

(1) Vertical Timing :

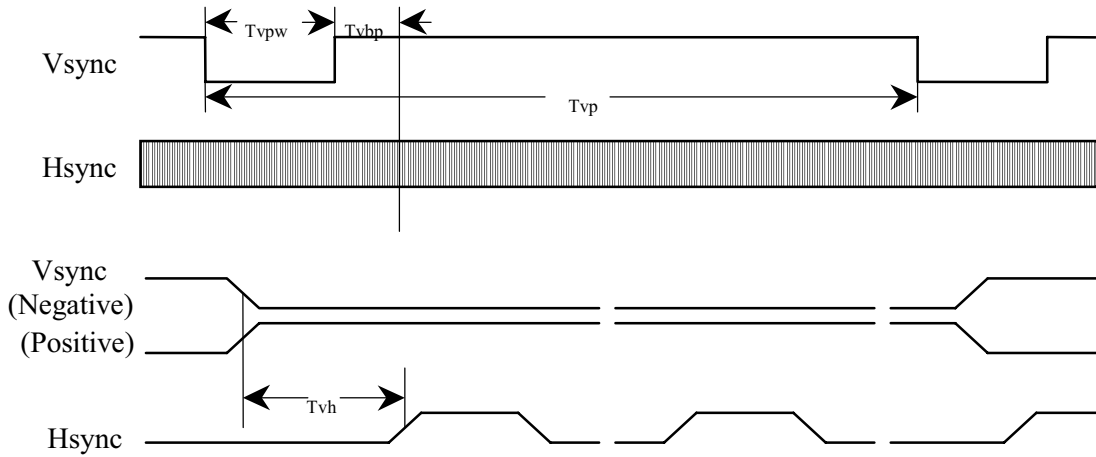

(2) Horizontal Timing :

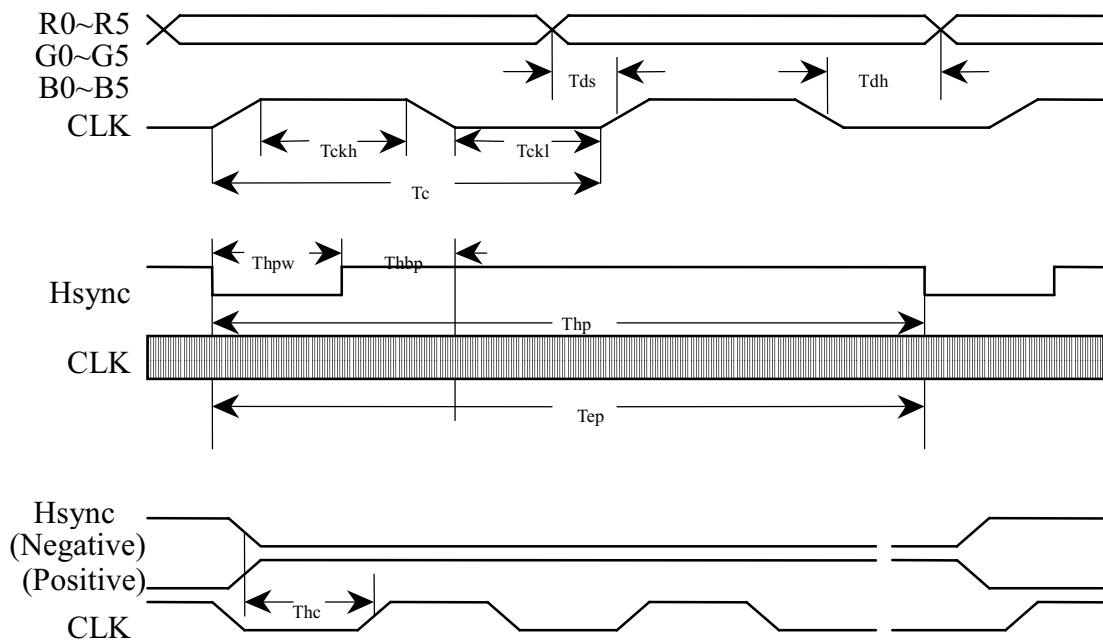

(3). Detail of Horizontal Timing :

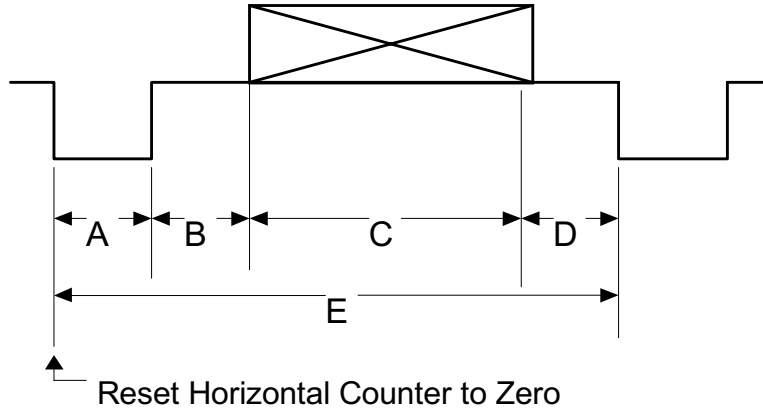

Item	Description	Clock Cycles	Time
A	Horizontal Width	96	3.813 μ s
B	Horizontal B-Porch	49	1.907 μ s
C	Horizontal Display	640	25.422 μ s
D	Horizontal F-Porch	16	0.636 μ s
E	Horizontal Total	800	31.778 μ s

(4). Detail of Vertical Timing :

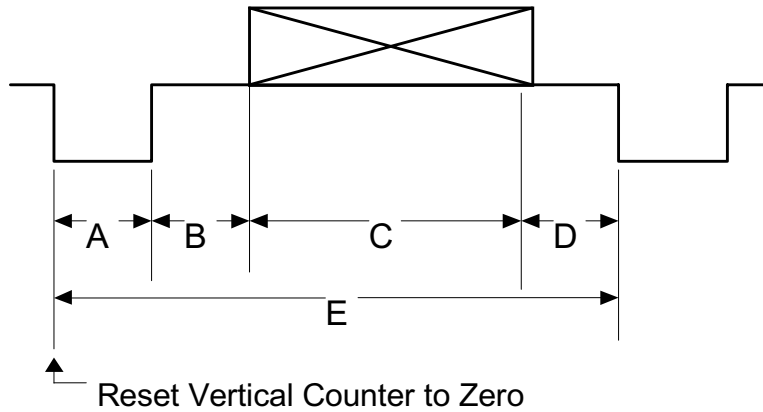

Item	Description	Horizontal Lines	Time
A	Vertical Width	2	63.5 μ s
B	Vertical B-Porch	33	1.049 ms
C	Vertical Display	480	15.253 ms
D	Vertical F-Porch	10	317.8 μ s
E	Vertical Total	525	16.683 ms

7-5) Pixel Arrangement

The LCD module pixel arrangement is the stripe.

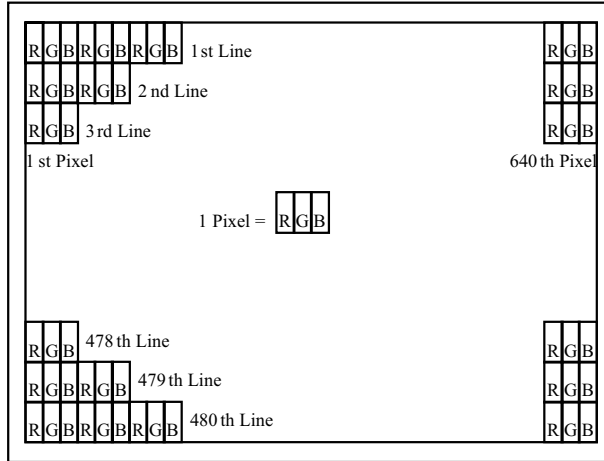

7-6) Display Color and Gray Scale Reference

Color		Input Color Data																	
		Red					Green					Blue							
		R5	R4	R3	R2	R1	R0	G5	G4	G3	G2	G1	G0	B5	B4	B3	B2	B1	B0
Basic Colors	Black	0	0	0	0	0	0	0	0	0	0	0	0	0	0	0	0	0	0
	Red (63)	1	1	1	1	1	1	0	0	0	0	0	0	0	0	0	0	0	0
	Green (63)	0	0	0	0	0	0	1	1	1	1	1	1	0	0	0	0	0	0
	Blue (63)	0	0	0	0	0	0	0	0	0	0	0	0	1	1	1	1	1	1
	Cyan	0	0	0	0	0	0	1	1	1	1	1	1	1	1	1	1	1	1
	Magenta	1	1	1	1	1	1	0	0	0	0	0	0	1	1	1	1	1	1
	Yellow	1	1	1	1	1	1	1	1	1	1	1	1	0	0	0	0	0	0
	White	1	1	1	1	1	1	1	1	1	1	1	1	1	1	1	1	1	1
Red	Red (00)	0	0	0	0	0	0	0	0	0	0	0	0	0	0	0	0	0	0
	Red (01)	0	0	0	0	0	1	0	0	0	0	0	0	0	0	0	0	0	0
	Red (02)	0	0	0	0	1	0	0	0	0	0	0	0	0	0	0	0	0	0
	Darker																		
	↓	↓	↓	↓	↓	↓	↓	↓	↓	↓	↓	↓	↓	↓	↓	↓	↓	↓	↓
	Brighter																		
	Red (61)	1	1	1	1	0	1	0	0	0	0	0	0	0	0	0	0	0	0
	Red (62)	1	1	1	1	1	0	0	0	0	0	0	0	0	0	0	0	0	0
Red (63)	1	1	1	1	1	1	0	0	0	0	0	0	0	0	0	0	0	0	
Green	Green (00)	0	0	0	0	0	0	0	0	0	0	0	0	0	0	0	0	0	0
	Green (01)	0	0	0	0	0	0	0	0	0	0	0	1	0	0	0	0	0	0
	Green (02)	0	0	0	0	0	0	0	0	0	0	1	0	0	0	0	0	0	0
	Darker																		
	↓	↓	↓	↓	↓	↓	↓	↓	↓	↓	↓	↓	↓	↓	↓	↓	↓	↓	↓
	Brighter																		
	Green (61)	0	0	0	0	0	0	1	1	1	1	0	1	0	0	0	0	0	0
	Green (62)	0	0	0	0	0	0	1	1	1	1	1	0	0	0	0	0	0	0
Green (63)	0	0	0	0	0	0	1	1	1	1	1	1	0	0	0	0	0	0	
Blue	Blue (00)	0	0	0	0	0	0	0	0	0	0	0	0	0	0	0	0	0	0
	Blue (01)	0	0	0	0	0	0	0	0	0	0	0	0	0	0	0	0	0	1
	Blue (02)	0	0	0	0	0	0	0	0	0	0	0	0	0	0	0	0	1	0
	Darker																		
	↓	↓	↓	↓	↓	↓	↓	↓	↓	↓	↓	↓	↓	↓	↓	↓	↓	↓	↓
	Brighter																		
	Blue (61)	0	0	0	0	0	0	0	0	0	0	0	0	1	1	1	1	0	1
	Blue (62)	0	0	0	0	0	0	0	0	0	0	0	0	1	1	1	1	1	0
Blue (63)	0	0	0	0	0	0	0	0	0	0	0	0	1	1	1	1	1	1	

8. Power On Sequence

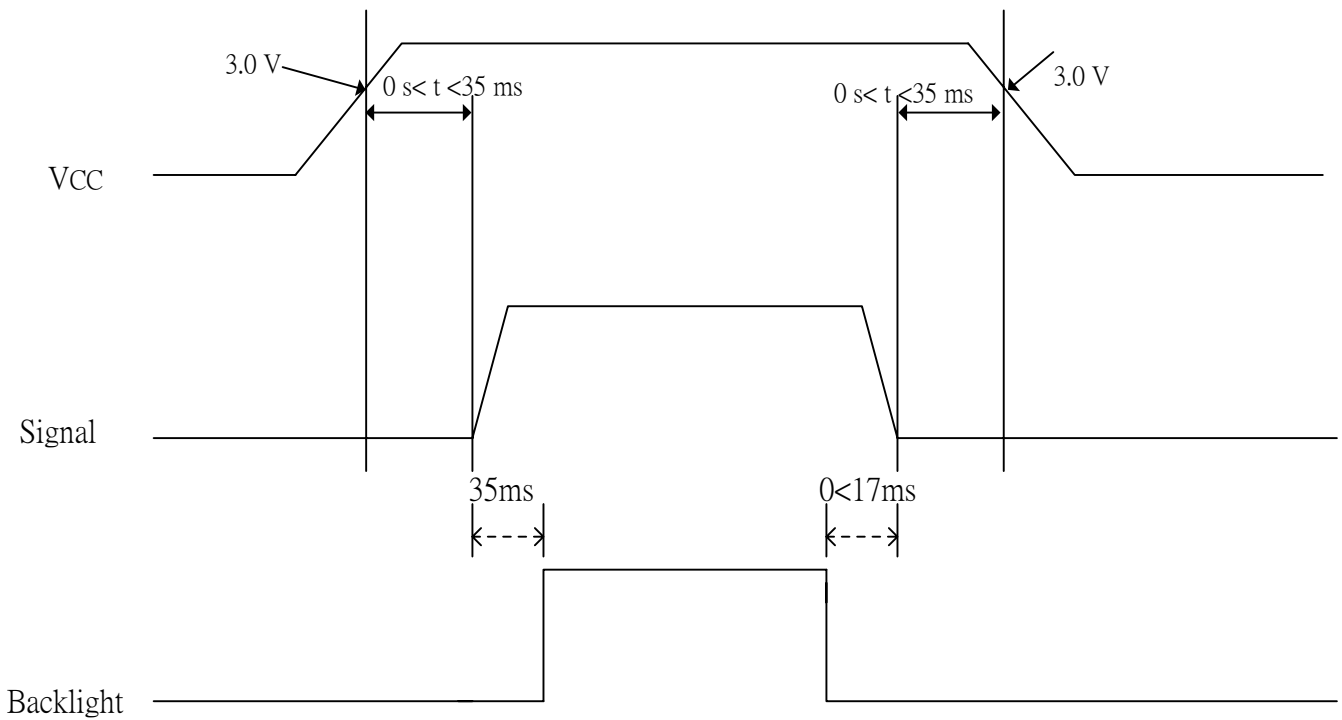

1. The supply voltage for input signals should be same as V_{CC} .
2. When the power is off , please keep whole signals (Hsync, Vsync, CLK, Data) low level or high impedance

9. Optical Characteristics

9-1) Specification:

Ta=25°C

Parameter		Symbol	Condition	MIN.	TYP.	MAX.	Unit	Remarks
Viewing Angle	Horizontal	θ	CR > 10	±35	±45		deg	Note 9-3
	Vertical	θ (to 12 o'clock)		10	15	-	deg	
		θ (to 6 o'clock)		30	35	-	deg	
Contrast Ratio		CR		150	180	-	-	Note 9-1
Response time	Rise	Tr	$\theta = 0^\circ$	-	15	30	ms	
	Fall	Tf		-	25	50	ms	
Brightness			$\theta = 0^\circ / \varphi = 0$	80	120		cd/m ²	Note 9-2
Lamp Life Time				-	20,000	-	hr	
White Chromaticity		x		0.230	0.280	0.330	-	
		y		0.270	0.320	0.370	-	
Cross Talk			$\theta = 0^\circ$	-	-	3	%	Note 9-4

Note 9-1 : CR = $\frac{\text{Luminance when LCD is White}}{\text{Luminance when LCD is Black}}$

Contrast Ratio is measured in optimum common electrode voltage.

Note 9-2 : Topcon BM-7(fast) luminance meter 2° field of view is used in the testing (after 20~30 minutes' operation).

Note 9-3 : The definitions of viewing angle diagrams:

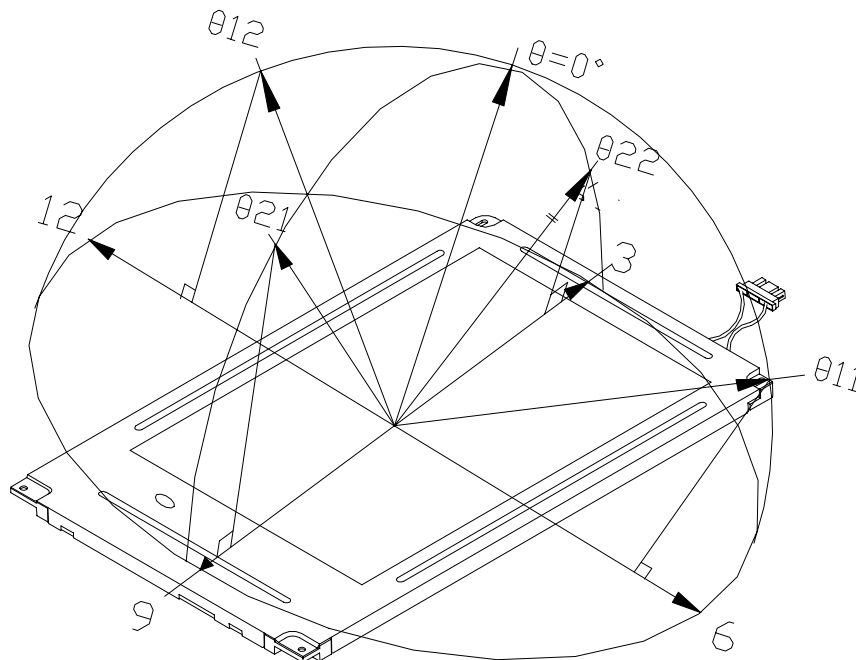

Note 9-4: Cross Talk (CTK) = $\frac{|YA-YB|}{YA} \times 100\%$

YA: Brightness of Pattern A

YB: Brightness of Pattern B
Pattern A

(Gray Level 31)

Pattern B

(Gray Level 31, central
black box exclusive)

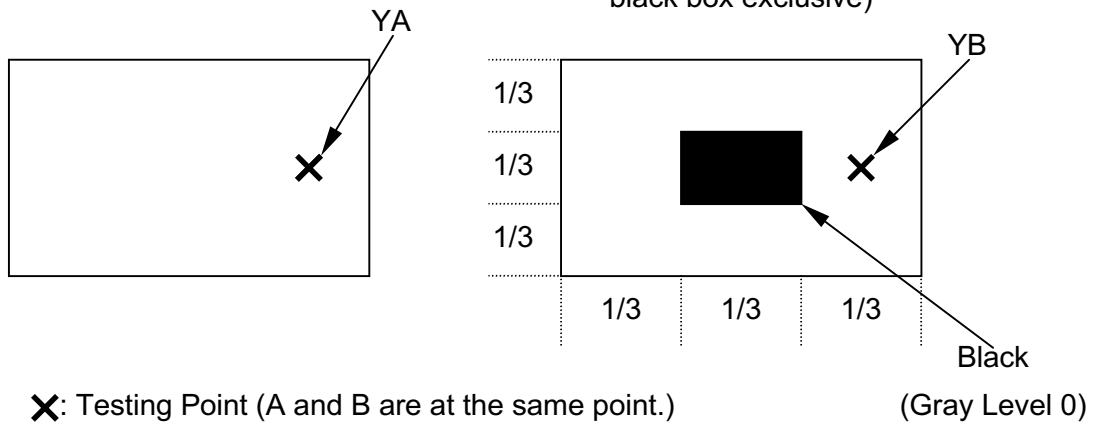

10. Reliability Test

No	Test Item	Test Condition
1	High Temperature Storage Test	Ta = +70 °C, 240 hrs
2	Low Temperature Storage Test	Ta = -20 °C, 240 hrs
3	High Temperature Operation Test	Ta = +60 °C, 240 hrs
4	Low Temperature Operation Test	Ta = 0 °C, 240 hrs
5	High Temperature & High Humidity Operation Test	Ta = +40 °C, 95%RH, 240 hrs
6	Thermal Cycling Test (non-operating))	-25°C → +25°C → +70°C , 200 Cycles 30 min 5min 30min
7	Vibration Test (non-operating)	Frequency : 10 ~ 57 Hz / Vibration Width : 0.075mm 58-500 Hz / Gravity : 9.8m/s ² Sweep time: 11 minutes Test period: 3 hrs for each direction of X, Y, Z
8	Shock Test (non-operating)	Gravity : 490m/s ² Direction: ± X, ± Y, ± Z Pulse Width : 11ms, half sine wave
9	Electrostatic Discharge Test (non-operating)	150pF , 330Ω Air : ±15KV ; Contact : ±8KV 10 times/point , 9 point/panel face

Ta: ambient temperature

[Judgement Criteria]

Under the display quality test conditions with normal operation state , there should be no change which may affect practical display function.

11. Block Diagram

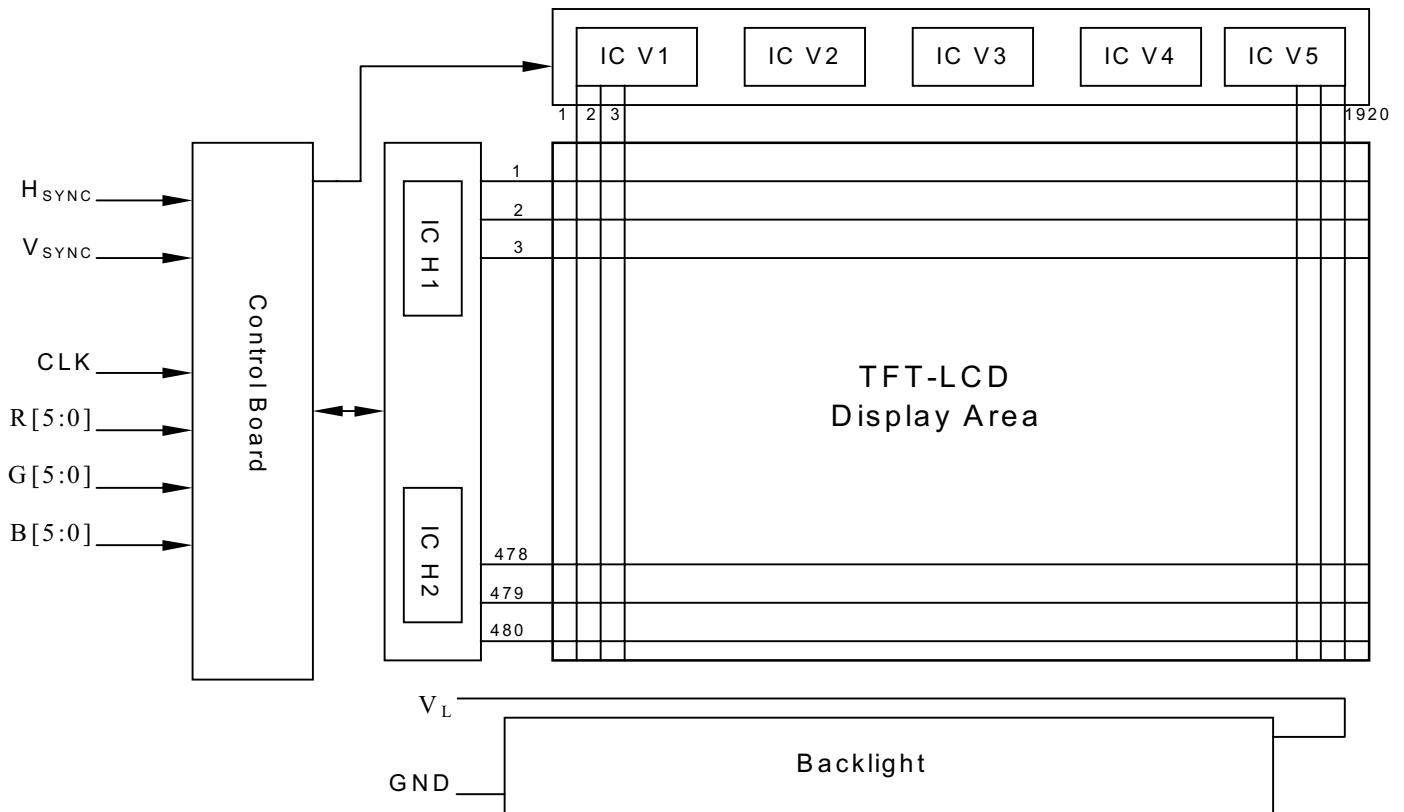

12. Packing Diagram

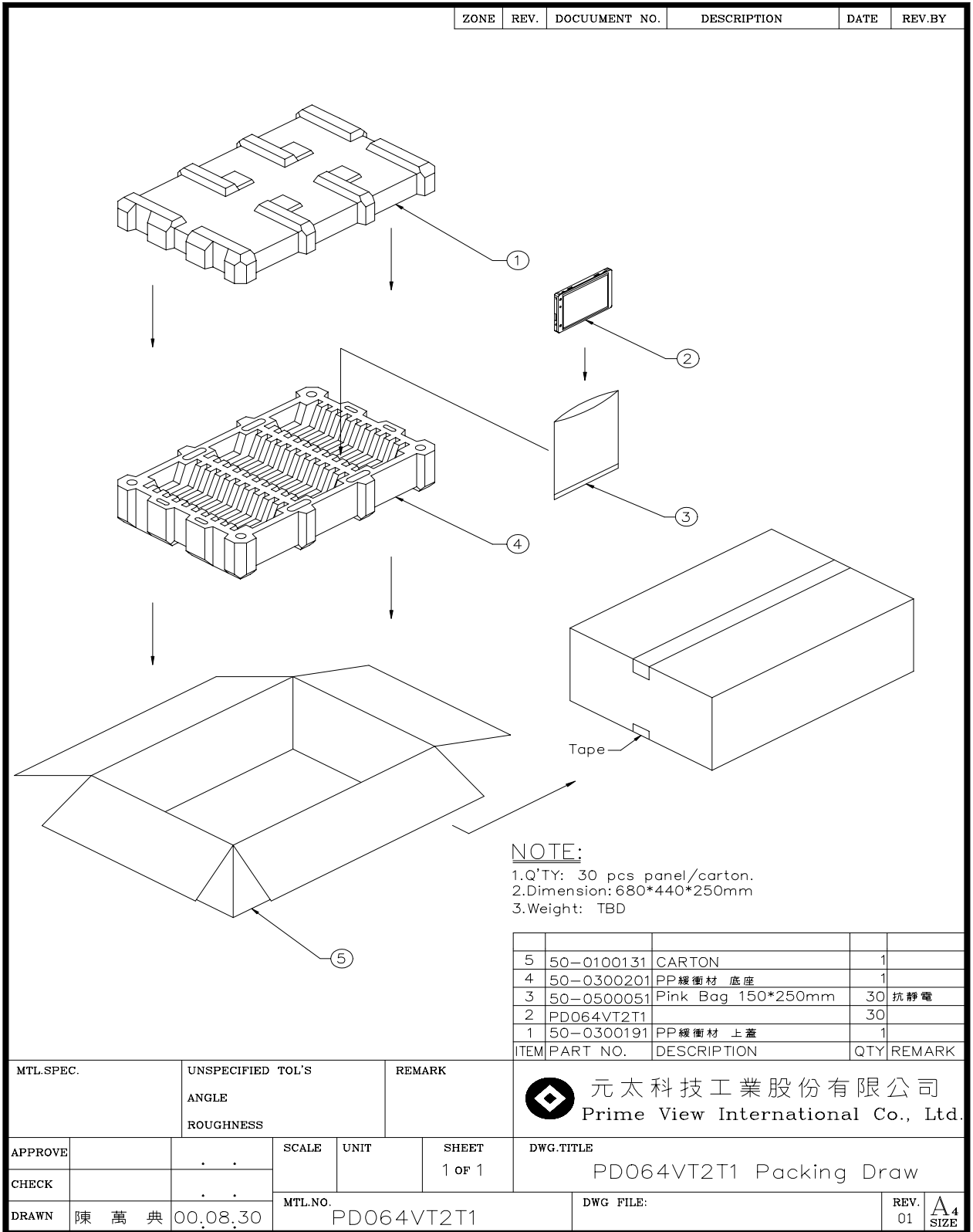

Revision History

Rev.	Issued Date	Revised Contents
Preliminary (0.1)	Aug. 29, 2000	NEW
Preliminary (0.2)	Sept,21, 2000	Revise
Preliminary (0.3)	Jan.,17, 2001	Modify 1. Input signals and voltage=3.3V (typ.) 2. Page7 : Thbp=49 clock, Tvbp=33 line
Preliminary (0.4)	Feb.,20, 2001	Modify 1. Page6 : Oscillation=64KHz ADD 1. Page6 : Kick-off voltage
Preliminary (0.5)	June, 04, 2001	Modify 1. 5-1) input pin define pin26 modify from "DENB" to "NC" 2. 7-1) Recommended operation condition Min. Input voltage modify from 3.0V to 3.15V 3. Erase original (7-6) Horizontal Display position, this section describes the "DENB" definition, which is useless in this module.
Preliminary (0.6)	July 20, 2001	Modify 1. Page4: 4.Mechanical Drawing of TFT-LCD Module 2. Page5: Connector(1) type : ELCO , 6210-30PIN
1.0	Aug 09,2001	Add Page12: Power On Sequence
1.1	Aug 15,2001	Modify 1. Page4:4.Mechanical Drawing of TFT-LCD Module 2. Page6:+3.3V Max. Supply Voltage from 7.0V to 4.0V.